



International guidelines on safe and efficient goods reception for road freight

<p>Mårten JOHANSSON Swedish Association of Road Transport Companies, Sweden Development Engineer, Halmstad University, Sweden. Currently director of Technical Affairs at SA, the Swedish Association of Road Transport Companies in Stockholm. Chairman of the Nordic Road Association Vehicles and Transports and President of the Commission on Technical Affairs (CIT) of the IRU and member of the board of the International Forum for Road Transport Technology, IFRTT</p>		<p>Jacques MARMY International Road Transport Union, CH. Automotive Engineer, ETS Bienne, Switzerland. Currently Head of Technical Affairs of the International Road Transport Union (IRU). He is Safety Adviser on Dangerous Goods for ADR/RID/ADN and member of the Board of the International Forum for Road Transport Technology, IFRTT.</p>	
--	---	---	---

Abstract

The International guidelines on safe and efficient goods reception for road freight provides information, rules and recommendations for different goods reception areas, taking into consideration safety, environment and cost effectiveness measures, enabling users to select the best solution based on its specific requirements. The guidelines include general information on goods reception areas intended to facilitate the loading and unloading of goods and aim to contribute to an efficient and safe working environment for all new and existing reception areas. The guidelines are also meant to help architects and warehouse companies take the right decisions when building or renovation goods reception areas. Commercial vehicle drivers, depot workers and many other stakeholders, including shop staff, cleaners and other employees, work on a daily basis in goods reception areas. Many injuries are reported every year of people collecting or delivering goods. Some accidents or incidents could have been prevented if all stakeholders involved (consignors, carriers, consignees) had cooperated and coordinated their work in a better way.

Keywords: Loading docks, safety, working environment, liability, responsibility, types of goods, types of heavy goods vehicles, load/unloading equipments.

* * * * *

1. The Basic Principles

1.1 Safe and efficient goods reception

There is a need for extensive construction and renovation of goods reception areas to prevent accidents and increase efficiency. It has also become more common for premises to be used by multiple businesses. The design of goods reception areas affects the safety of all those involved in the delivery chain, and these guidelines will help promote a safer and more efficient working environment in such areas.

There are two main aspects of safety that should be considered in relation to goods reception:

- traffic safety: the way in which a vehicle approaches and departs a goods reception, which can affect members of the public such as customers, those living in the vicinity and children;
- workplace safety: the way in which the vehicle docks at the goods reception, which can affect the safety of workers such as commercial drivers and warehouse staff.

It is also important to remember that the design of goods receptions may affect evacuation options, risk of fire, risk of theft, etc. The function of dock seals and air lock devices will also affect the working environment for those working in the goods reception area. These guidelines are aimed at stakeholders in many different industries and professions. They aim to influence how goods receptions are planned, designed and used. The recommendations in these guidelines are based on proven experiences and good practice examples.

1.2 Common goods reception areas

The goods reception design will vary depending on the type of vehicle combination that normally uses it. A typical goods reception is designed to facilitate loading and unloading, delivering and collecting of goods. The planning of how the goods reception is accessed affects safety, the working environment and work operations. Factors that affect people in the vicinity of the goods reception will be addressed in this guidance. For loading and unloading

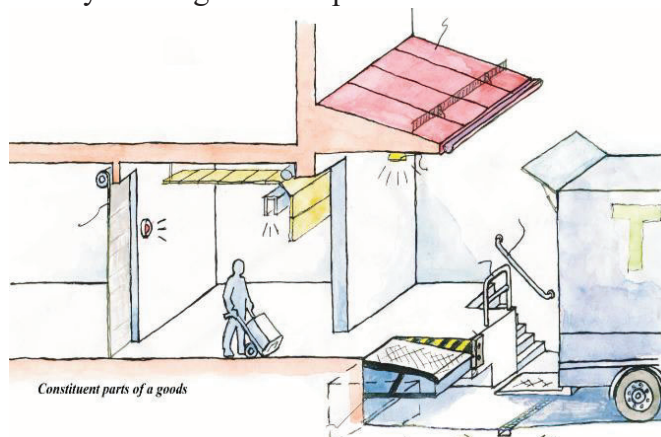

work to be carried out effectively, efficiently and safely, additional equipment may be required to make sure good ergonomic handling practices are followed. That is why loading receptions situated outside the building, comprising a gate, a dock seal and a dock leveller, are common. The loading dock and goods reception with associated equipment shape a docking system.

Figure 1: Common goods reception

2. Fitting the goods reception to the environment

2.1 Depot / warehouse

There are often several different vehicle types operating at a depot or warehouse at any time. This means traffic planning is essential and information has to be provided about which rules apply to vehicle movements. It should be possible to reverse the vehicle up to the loading dock without disrupting other traffic and to get transport units into position without getting in the way of other traffic and people. The nature of the business determines how safe and efficient goods reception at depots and warehouses should be designed. It should be possible to load and unload vehicles of varying sizes, including HGVs which need to 'dock' into the loading bay. The goods reception area should have loading docks with different heights and different seals to accommodate different HGV types and vans.

A goods reception at a depot, all loading and unloading take place inside or via a weather

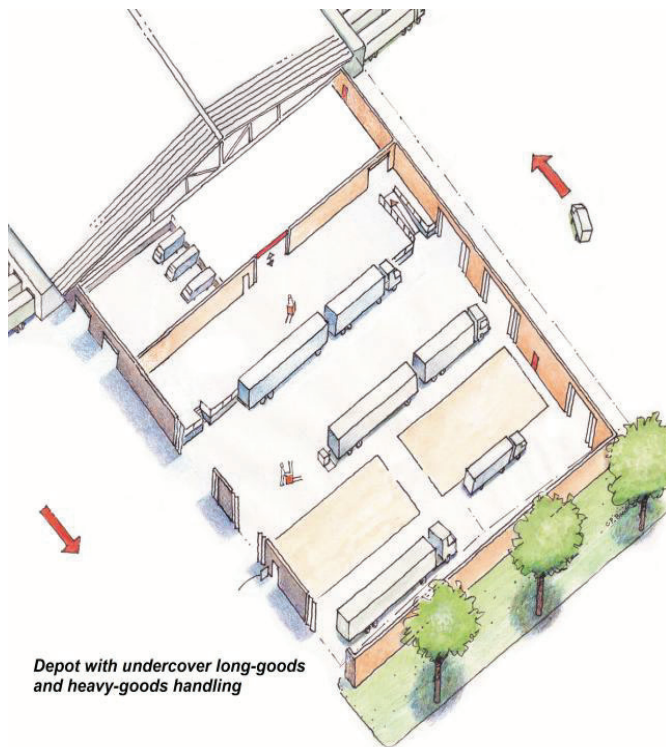

tight loading house that protects employees from adverse weather conditions (such as rain, ice, snow and wind) and reduces the risk of incidents or accidents. In the example below, it is assumed that traffic in the depot's goods reception is one-way and clearly planned. The example also has several different areas for forklifts and other handling equipment. One advantage of this goods reception setup is that a vehicle loaded with long goods, heavy goods and general goods can be unloaded in one location in a logical order from both the loading dock and at ground level using forklift trucks. Close to the goods reception, there is a drivers' area with lunchroom, toilet and shower.

Figure 2: Depot / warehouse

2.2 Industrial facility

At industrial facilities there is a need to handle different types of goods that are both long and heavy. There may be several different types of vehicle, including service vehicles. In addition to the work involving loading and unloading, there may be frequent entering and exiting with goods while production is underway in the goods reception area. Loading and unloading takes place, either from/onto a loading dock or at ground level. Loading and unloading of general goods can take place from/onto loading docks with loading docks and docking systems. Large

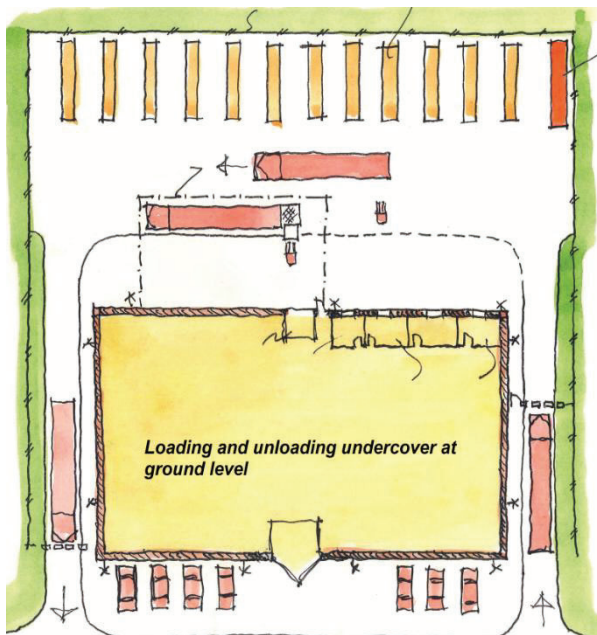

goods are best unloaded under a cover at loading dock level. Loading and unloading can also take place under a cover at ground level using forklifts. Entry to warehouse or industrial premises takes place at ground level.

Figure 3: Outside storage of material; fence; combustible material storage; canopy; temporary goods storage; non-combustible goods storage; wc/shower; air lock; lunchroom; drivers' room; industry; room; entrance; disabled parking; loading and unloading under a cover at ground level.

In this example, access to and from the area is controlled using gates or barriers to prevent unauthorised traffic and pedestrians (workers and visitors). The traffic in the area is one-way. Combustible material is stored at a safe distance from the main building. Loading and unloading takes place under a cover in a secure area. To minimise draughts between the docking system and work premises, there is an air lock with a combination of rapid gates for entering and exiting with industrial trucks. Close to goods reception, there is a drivers' area with lunchroom, toilet and shower. Another solution for industries with limited space might be to receive goods through loading docks positioned at a 45-degree angle. Such a solution both presupposes and facilitates a one-way traffic flow.

2.3 Superstore

The environment at a superstore is characterised by frequent deliveries of goods and high levels of customer traffic. Goods of a vastly varying nature are delivered to superstores – everything from building and garden products to food. A safe and efficient goods reception area at a supermarket needs to be located so that no goods need to be loaded or unloaded among customers on their way into or out of the superstore. Handling requires there to be room for goods, return goods and other material, and for there to be access for transport units.

The loading docks have been positioned at a 45-degree angle towards the rear of the superstore due to limited space. This facilitates a one-way traffic flow and reversing traffic. Customer traffic and goods traffic are separated effectively. There are stations for loading and unloading several different truck types and an area for large goods handling. Driving areas should allow enough manoeuvring room for transport units with and without trailers. Loading docks at a superstore should be equipped with dock levellers and dock seals so that neither the driver nor consignees are exposed to weather elements. Chilled and frozen food should be handled in an unbroken cold chain. If it is not possible to have the entire goods reception area indoors or there is not enough space for a loading house/docking system, there should be

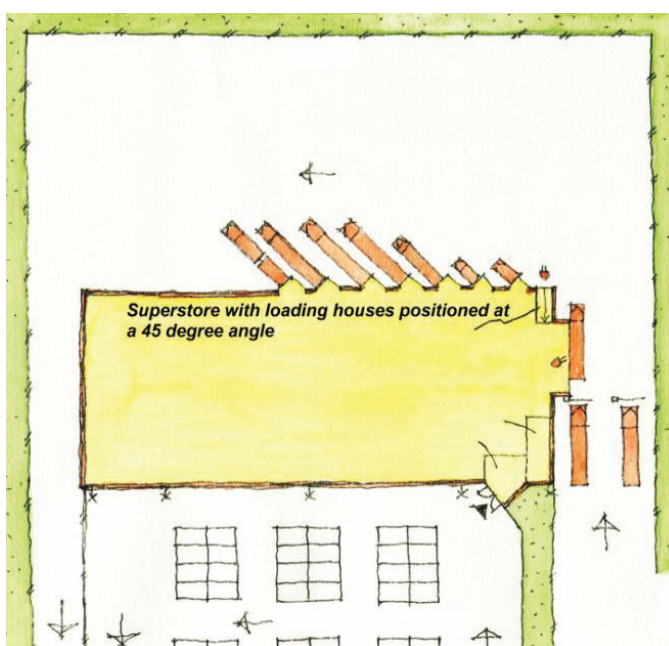

canopies to protect people from rain and reduce the risk of slips, trips and falls. Stairs should not be used for the manual handling of goods, or for pushing or carrying hand trucks or cages. The floor should have even surfaces and be all on the same level so that rolling handling with pallets, trolleys and wheeled cages can take place without jolts or lifting. It is also important to make sure floor surfaces are made of slip resistant materials to reduced risks of slips, trips and falls, particularly when wet. Doors and fire doors should not have doorsteps. It should be possible to keep doors open to allow passage.

Figure 4: Superstore

2.4 Preschool, school

Goods deliveries to preschools and schools involve an obvious risk of children being hit or run over by a large vehicle or sustaining injuries as goods are being unloaded. Many preschools are arranged in a way that is good for learning, but this layout also means goods cannot be delivered without considerable difficulty. The same also applies to many schools. Safe and efficient goods reception is arranged so that people, (particularly children) and traffic are kept as separate as possible. The most frequent operations involve food products, waste, fuels and school materials, but there may also be other types of delivery. If all deliveries can be made to the same place, this means there is as little traffic in the area for as short a time as possible. Kitchens should be located close to goods reception. The driver should not have to reverse the vehicle in the vicinity of children or other people. That is why goods reception should be located in an external wall facing the road. The access road to goods reception should have a fence so that children cannot run out in front of the vehicle. In the example below, roads for commercial traffic and other traffic are separate. The children's way to school and playground is separate to the road for commercial transport. The goods reception area is located in the external wall and equipped with a canopy.

Goods reception should ideally be equipped with a loading dock or lifting platform. There should be a canopy that both protects people from rain and reduces the risk of slipping. Stairs should not be used for manually carrying goods, or for pushing or carrying hand trucks or cages. If the storage area is not at street level, it should be possible to reach this using a lift big enough for the driver and lifting truck with pallet.

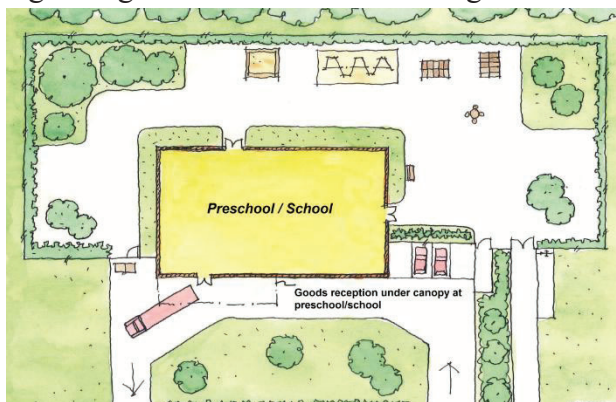

Floors should be even and all on the same level so that rolling handling with pallets, trolleys and wheeled cages can take place without jolts or lifting. Doors and fire doors should not have doorsteps. Goods, return goods and other materials should not be in the way of operations in corridors and access aisles; they should instead be stored in separate areas. It should be possible to keep doors open to allow passage.

Figure 5: Preschool, school: Sandpit; swings; playground; preschool/school; P; disabled parking; bike park; waste; sorting; canopy; loading area; visitor drop-off; goods reception under canopy at preschool/school.

2.5 Industrial kitchen, hospital, hotel

Operations in industrial kitchens, hospitals and hotels may involve people-focused activities being carried out within the goods reception area. It means that at such establishments, large quantities of laundry and other materials that have to be handled separately are handled in addition to food products. The way that safe and efficient goods reception at industrial kitchens, hospitals and hotels is set up varies according to the size and location of the establishment. Driving areas and access roads should be designed for the vehicle type that tends to use them the most. Bigger premises should have loading docks and be equipped to handle goods with pallets and wheeled cages to make sure those activities are safe. There should be a canopy above the loading dock to protect people from rain and reduce the risk of

slips, trips and falls on wet floors. Floors should be even and all on the same level so that rolling handling with pallets, trolleys and wheeled cages can take place without jolts or lifting. Floor surfaces should be constructed with slip resistance materials to avoid slips, trips and falls. Doors and fire doors should not have doorsteps. Goods, return goods and other material should not be in the way of transports in corridors and access aisles; they should instead be stored in separate areas. It should be possible to keep doors open to allow passage. This goods reception has different gates through which different types of commercial transports drive in and out. At each goods reception you will also find the containers or other areas, including both cold and normal refuse storage rooms, required for each goods type. Goods reception is set up so that loading and unloading take place undercover and there is a clear one-way traffic flow.



and out. At each goods reception you will also find the containers or other areas, including both cold and normal refuse storage rooms, required for each goods type. Goods reception is set up so that loading and unloading take place undercover and there is a clear one-way traffic flow.

Figure 6: Industrial kitchen, hospital, hotel

2.6 Shopping centre shopping mall

In shopping centres and shopping malls, there are many goods reception areas where a variety of activities are carried out. It means that such premises generate very large volumes of goods traffic. These should be streamlined to the greatest extent possible. A model that has been proven to work well for shops, carriers and property owners alike is a shared jointly staffed goods reception area. When the driver arrives at one of these shopping centres, the goods reception employees can process the different shops' consignment notes while the driver unloads the goods. Handling cargos at goods reception is quick and very little time is spent at the loading dock. As a consequence, other vehicles arriving do not have to queue for a long time to use the loading dock. There are containers in place for sorting different waste streams such as glass, cardboard, and metal. Access to a designated container lift is provided to allow emptying of the refuse containers. Containers are positioned so that they can be reached directly from the loading dock and employees do not have to walk among reversing vehicles. Having a shared goods reception means the driver does not have to contact the consignor or consignee and wait for them to come to the loading dock to receive the goods.

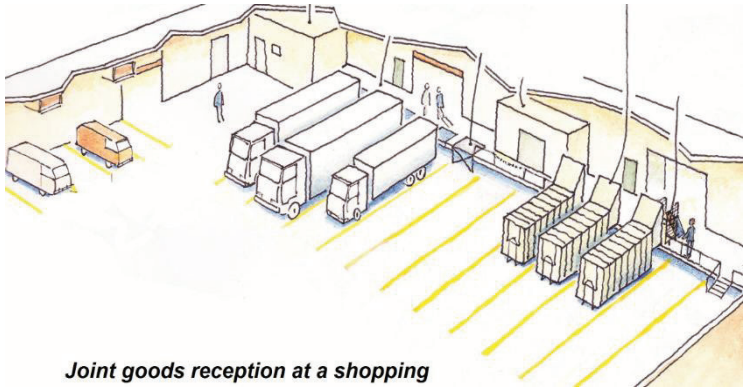

Joint goods reception at a shopping

Figure 7: The example demonstrates a common goods reception at a shopping centre. Different vehicle types with different tasks can make use of aspects of the goods reception area without getting in each other's way. The example also shows a separate delivery van area

Unless otherwise stated in the delivery conditions, the driver does not have to take the goods to the shop either and this lessens the risk of manual handling injury, theft and injury to visitors to the centre (risk of hitting someone with a pallet lift and similar equipment). The goods will either be temporarily stored at the shared goods reception and transported on into the shopping centre using internal transport or a shop employee will come to the shared goods reception to collect the goods when it is appropriate and safe for them to do so.

2.7 Medium-sized –small shop, pubs, restaurant, kiosk

There are many medium-sized shops in urban environments in particular – smaller department stores, specialist shops and food shops – that receive many goods deliveries from different suppliers on a daily basis. These businesses generate a lot of return goods in the form of trolleys and pallets as well as large quantities of packaging to be taken away after sorting. These medium-sized shops are of course located where the customers are, which often means poor conditions for goods deliveries and often take place on busy streets with pedestrians and other types of traffic. In these environments the conditions for safe goods handling are often limited. The way that safe and efficient goods reception is set up varies according to the size and location of the establishment and the local traffic conditions. One important requirement is that a driver should be able to call at the goods reception easily and safely, thereby parking their vehicle legally without having to walk too far. The driver should be able to contact the shop employee using an accessible bell or similar device. Where several premises use the same goods reception area, there should be a loading dock with lifting platform. Where deliveries are made on the street, handling of goods, trolleys and pallets should be possible without stairs or level differences. Vehicles should be able to park on hard level ground to allow for ease of pushing and pulling of pallets and cages of goods in particular.

The condition and arrangement of public roads, pathways and footpaths is often not under the direct control of the business owner. But if issues arise with the safety of roads and path

surfaces that are necessary for access to business premises, the business owner should report concerns to the responsible.

The floors outside and within premises should be even and all on the same level so that rolling handling with pallets, trolleys and wheeled cages can take place without jolts or lifting. Floor surfaces should be constructed with slip resistance materials to avoid slips, trips and falls. Doors and fire doors should not have doorsteps. If there are level differences, a lifting platform should be used. Goods, return goods and other material should not be in the way of transports in corridors and transport routes, but should be stored in a separate area. It should be possible to keep doors open to allow passage.



Figure 8: Logistic zone

Since the vehicle has to be horizontal, the logistics zone and its unloading platform should not be on a slope. These surfaces should be level. Heating coils can solve certain snow clearance problems in the logistics zone. The safety of all road users, particularly the elderly, children, visually impaired people, cyclists and those with physical disabilities should be considered. Adequate signs and warnings should be employed by delivery drivers and premises owners to make sure all vulnerable road users are not put at risk during delivery. The height of the platform is 100–120 mm, level with the raised crossing. The logistics zone’s total length should be 20 metres. This length is required to remove the need for reversing within the zone.

3. Key design considerations for goods reception elements

This section of the guidance deals with specific elements of goods reception design and highlights key elements that are required to achieve safe and efficient operations.

3.1 Goods reception design

For larger premises, the goods reception area is normally located within the boundary. The simplest goods reception design consists of an opening in the wall with a loading dock outside, apart from in those cases where goods reception takes place at ground level, which is usually under a cover. Typically to separate the outside climate from the inside climate, goods reception is cut off from the rest of the indoor environment by an air lock.

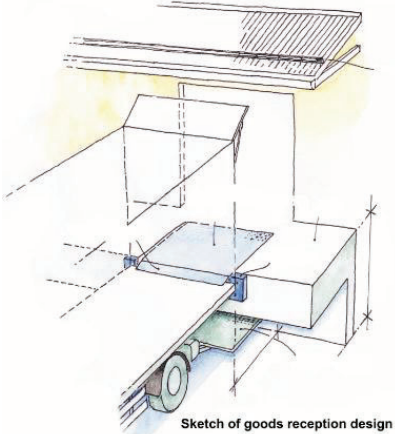

Sketch of goods reception design

The purpose of a loading dock is to compensate for any difference in level between the vehicle trailer platform and the unloading area. A dock leveller is used to quickly connect the vehicle trailer platform to the loading dock and to even out any height difference between the loading dock and vehicle trailer platform. Goods reception areas should not have doorsteps. It should be possible to keep doors open. Combustible material should be kept in a lockable, fireproof store or at least six metres away from the building.

Figure 9: Goods reception design

3.3 Loading house

To save floor areas indoors, reduce the risk of weather elements and ensure a good working environment during loading and unloading, the loading and unloading zone can be located outside by means of a loading dock to which the loading vehicle can connect through docking. When the vehicle has docked, a dock seal will be activated that makes it possible for loading and unloading to take place protected from the weather elements.

Figure 10: Description: Storage area; dock seal; truck; loading house; layout sketch; snow guard; gutter; dock seal; storage area; recessed dock leveller; buffer; space for tailboard lift; loading house; cross-section

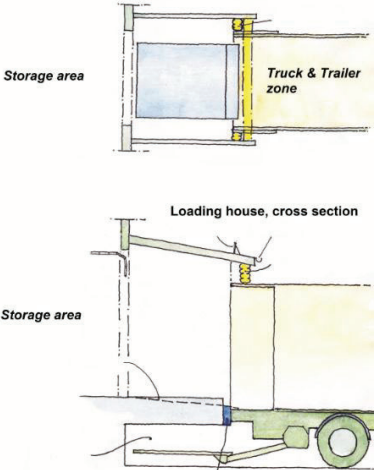

3.3 Gates

The most common types of gate used in the external wall are up-and-over or folding gates. The local situation determines your choice, in other words what the traffic is like and the layout of the area. Please note that pedestrian and vehicle traffic should be separated by means barriers, doors or gates. There should be a separate door for pedestrians next to gates for vehicles. Up-and-over gates should be used for openings at loading dock height. Up-and-over or folding gates should be used for goods reception at ground level.

3.4 Gate dimensioning

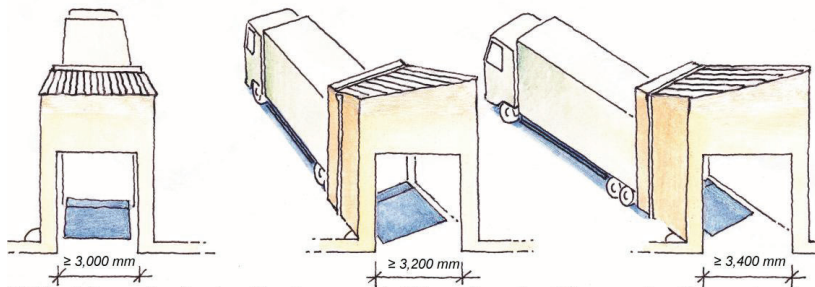

With of the gates for loading houses at different angles. The smaller the angle of the loading house, the wider is the gate.

Figure 11: Width of gates for loading docks at different angles. The smaller the angle of the loading house, the wider the gate required.

To minimise damage to the gates caused by industrial trucks, a good gate height is at least 3,600 mm. A greater height is required in the event of double staked pallet handling.

The following widths should be used:

- 90-degree docking system: at least 3,000 mm
- 60-degree docking system: at least 3,200 mm
- 45 and 30-degree docking systems: at least 3,400 mm

The gate opening height is normally dimensioned based on the highest conceivable vehicle height with additional space to compensate for any slope. Trucks are normally up to 4,500 mm high (4,000 mm international transport), which corresponds to vertical clearance in the road network. Gates for these vehicles are sized at 4,000 x 5,100 mm (width x height). This depends on the slope of the ground.

3.5 Loading Dock

When dimensioning the loading dock, think about different types of large vehicles (HGVs and large LGVs in particular) and how they can interact with loading dock height, dock levellers and other local conditions. Excessive differences in height between the loading dock and trailer platform are unsafe because they lead to a risk of slips, trips and falls as well as goods movement problems. A large difference in levels between the loading dock and vehicle platform cannot be compensated by using a dock leveller. A normal height range for a loading dock is 1000-1350 mm, which corresponds to the trailer platform height of most large transport units. For some vehicles with low platform heights, the loading dock height should be adjusted. Certain goods reception areas may require several loading docks of different heights. Lifting platforms may be used in certain cases.

3.6 Dock leveller

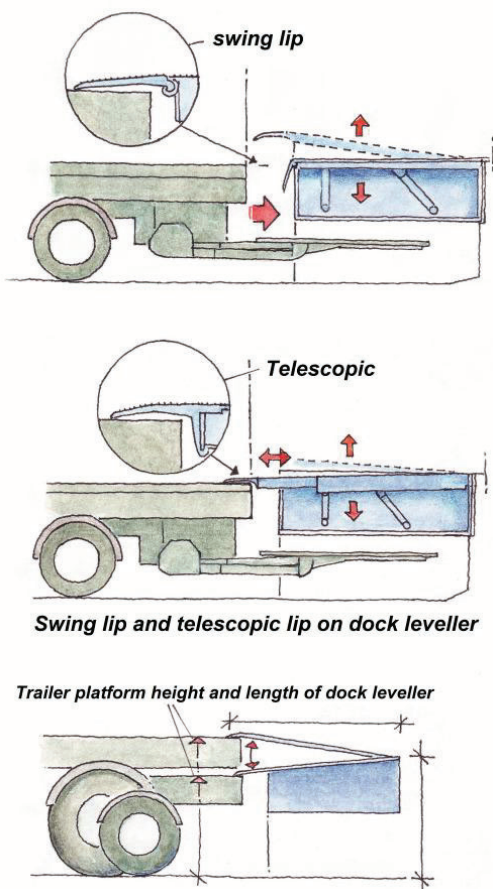

A dock leveller is used to compensate for differences in height between loading docks and vehicle platforms. Tailboard lifts should not be placed on top of dock levellers. Dock levellers are available in different lengths and widths, and can be equipped with different lip designs. The most common lip designs are 'swing' and 'telescopic'. A dock leveller that is 2,500 mm long can tolerate a height difference of ± 250 mm between the vehicle platform and loading dock. There should be space for the vehicle's tailboard lift under the dock leveller. For safety reasons, dock levellers with automatic return should never be used. Many serious personal injuries have occurred to drivers and operatives who were crushed or trapped between motorised handling equipment (such as hand pallet trucks) and automatic dock levellers. A ramp should have an incline of maximum 1:12 and a maximum height of 0.5 meters between the loading dock and the vehicle platform for manual handling. If the incline is greater than 1:12, then motorised lift trucks may be necessary.

Figure 12: Dock leveller

Dock leveller formula

The gradient as a percentage is calculated as follows:

$$\frac{(\text{Vehicle trailer platform height} - \text{loading dock height}) \times 100}{(\text{lengths of dock leveller} + \text{lip})}$$

3.7 Swing lip and telescopic lip and dock leveller

Dock levellers are normally 2,500 mm long, which allows the height to be varied in relation to different trailer platform heights. This applies when loading and unloading via the vehicle's rear doors. For side loading, there are different solutions involving hydraulic bridges equipped with longer telescopic lips (up to 1,000 mm long). The gate is normally fitted on the inside of the wall and the loading system controls are inside the gate. The controls should be located close to the gate so that the risk area can be monitored. If the gate is closed, it should be equipped with a window or "peephole". There should be lighting inside the loading house. If these safety features are not in place, the gate and dock leveller should be interlocked so that the dock leveller cannot be moved until you have full view of the dock leveller.

3.8 Safe docking

When a vehicle arrives at goods reception, it is important for safety reasons that the vehicle is docked in the following order:

- a) Position the vehicle securely next to dock leveller
- b) Activate dock seal activated
- c) Switch on interior lighting in goods reception
- d) Open gate
- e) Move dock leveller into work position when a vehicle leaves goods reception.

These steps should then take place in reverse order.

3.9 Dock seals

Dock seals are used to protect workers from weather conditions, as well as for transport that require unbroken temperature chains. They enclose the vehicle when it has been reversed up to the dock. There are also loading docks configurations that allow the vehicle doors to be opened after it has been reversed towards the platform and the dock seal has been inflated. This means reversing with the doors open is avoided, an action that is risky due to impaired vision and the fact that goods might fall out. Loading docks with a platform equipped with a step are also useful when an unbroken temperature chain is required.

Layout sketch - Cross-section

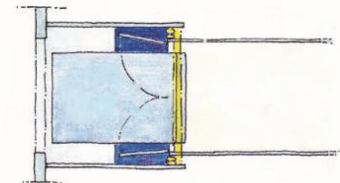

Loading house with the option of opening the vehicle's rear doors inside the loading

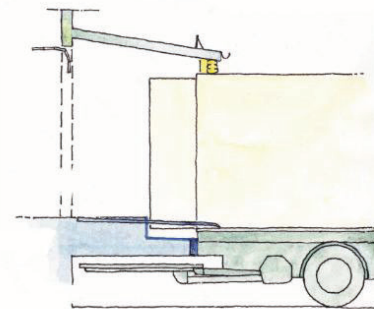

Loading house with the option of opening the vehicle's rear doors inside the loading house.

Figure 13: Loading House

3.10 Securing a vehicle or load carrier

The dedicated driving area is normally structured so that the ground slopes away from the loading dock with a minimum gradient of 1:100. To prevent vehicles at dock levellers from rolling, the ground may slope 1:100 towards the dock (which requires drainage to be taken into consideration). Vehicles or load carriers should always be secured to the dock leveller if motorised handling equipment or forklifts are being used to move goods via the dock leveller to or from vehicles or load carriers. In addition to an activated parking brake, the vehicle or load carrier floor should be equipped with suitable loops or other devices for securing to the dock leveller using straps, which is a more secure method than chock blocks.

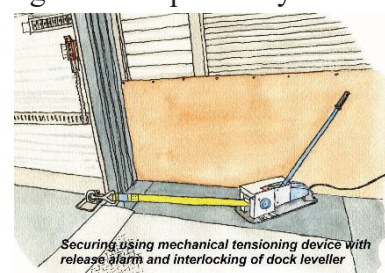

Securing using mechanical tensing device with release alarm and interlocking of dock leveller

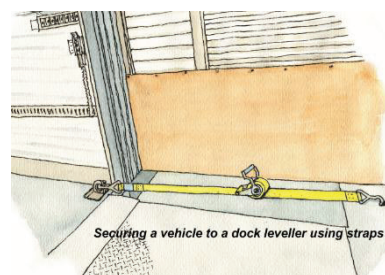

Securing a vehicle to a dock leveller using straps

Figure 14 and 15: Securing a vehicle

Drivers of motorised handling equipment or forklifts should make sure that the vehicle or load carrier is secured to the dock leveller and that the load carrier floor is dimensioned for the motorised handling aid being used.

3.11 Handling equipment

Transport hazards that exist in the workplace must be assessed and appropriate steps taken to eliminate or reduce any risks found. A risk assessment should be carried out before the selection and use of handling equipment. Handling equipment is extremely useful, as long as it is used safely and appropriately by operators who are appropriately trained and competent. Handling equipment can be dangerous. Many workplace accidents involve people being hit or run over by forklift trucks (typically when the forklift is reversing) because the driver did not see them. Because of their size and weight, injuries resulting from forklifts are generally very serious. Accidents are often caused by poor supervision and a lack of training. Employers must make sure that forklifts are provided in a safe condition for use at work. This can be achieved by having a preventative maintenance system which includes scheduled checks as per the manufacturer's instructions. Anyone operating forklifts should have the necessary training, authorisation and skills to drive this type of truck.

3.12 Traffic management

Vehicles and trailers need a lot of space to manoeuvre safely. This is why access routes should be planned with workplace transport safety in mind. In general for left hand drive vehicles, it is recommended to plan left hand turns and vice-versa for right hand drive vehicles – in order mitigate blind spots while manoeuvring. Different types of traffic should be separated from each other and, most importantly, separated from vulnerable road users and pedestrians. Access routes to goods reception areas, as well as driving areas, should be planned so that reversing is avoided or minimised. Vegetation around access roads and driving areas should be designed so that it does not block the driver's view, depending on the season. Driving areas should also be planned so that they facilitate safe driving behaviour, good drainage, lighting, signs, vision and ice and snow clearance.

3.12.1 Vehicle routes

When a vehicle is reversed up to a loading dock, vehicles should only use designated and signposted vehicle routes. Routes will vary depending vehicle dimensions. Premises should set out one-way systems to remove the risks of injury and collision from reversing vehicles. If reversing is unavoidable due to premises constraints, then this should be done safely, and in a designated area for reversing. The area in front of a loading dock should allow for sufficient space for parking of other vehicles, and should allow sufficient space for the driver to exit the vehicle cab and make their way to the driver refuge. For a loading dock at a 90-degree angle to the dock, it is recommended that the vehicle path should correspond to twice the length of the vehicle – see also figure 19.

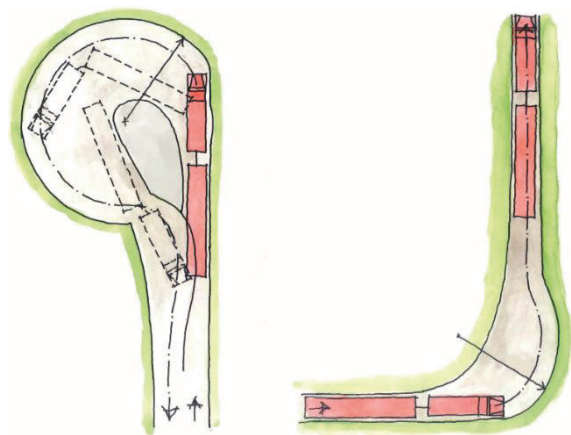

Figure 16: Vehicle routes for 25.25 m vehicle combinations

Therefore, a 25.25 m vehicle combination requires 50.00 m of free space in front of the dock, plus space for walking, exiting the vehicle and parking. There should be suitable reversing lines to facilitate reversing to a loading dock, and the distance between vehicles should be approximately 1.5 m, allowing the rear doors of the vehicle to be opened before it docks with the loading house. Easy driving can be achieved by ensuring an outer radius of 15 metres and that the space outside the vehicle route is kept clear of obstacles. The goods reception area should also have the same loading capacity- single/boggie/triple axle loads - as the vehicle route. Note that vehicle routes may vary depending on the vehicle design, wheelbase, varying loads and ground surface.

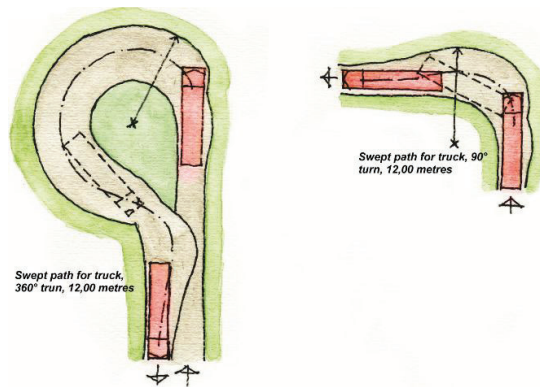

Figure 17: Vehicle routes, 360° and 90° turns

3.13 Moving between different slopes

When planning vehicle parking bays with level differences, remember that a vehicle requires more vertical clearance on a slope than on flat ground as well as when moving between different slopes. When moving from a flat surface to a downwards slope, the vehicle's overhang will be raised. In the reverse situation, when moving from a flat surface to an upwards slope, the vehicle's middle section will be raised. Note that installations and signs suspended from the ceiling may encroach on a vehicle's manoeuvring space and that an empty vehicle is higher than a loaded vehicle.

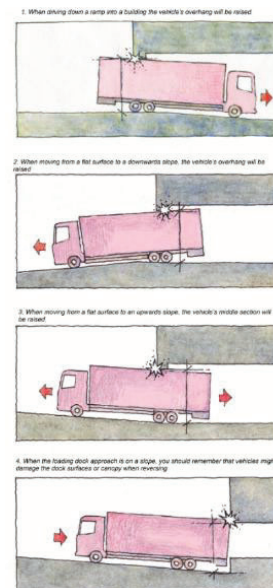
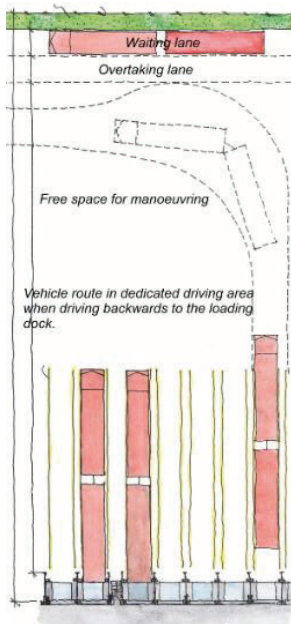

Figure 18: Moving between different slopes

3.14 Help reversing

To facilitate safe reversing, it is important that loading docks look like they are angled to the left in relation to the façade when the driver looks in their left rear-view mirror when reversing. When it is dark outdoor or limited visibility at goods reception, the docking system should be lit using external lighting. Note that any risk of glare should be avoided. The closer together vehicles are parked, the better the lighting between the vehicles needs to be, even at dusk. Yellow reversing lines provide guidance for the drivers and permit safer reversing. The reversing lines should align with the vehicle tyres, not with the outer edge of the trailer. It is also a good idea to have distance markings on the ground to help the driver judge the distance when reversing up to a loading dock. Reversing lines may be difficult to see if they are covered by snow, worn away or it is dark outside. To facilitate reversing, visual support can be provided to the driver using lights mounted on the front of the docking system that indicate the position of the reversing lines



The distance between the reversing lines should be at least 700 mm for the driver to be able to move around in the loading and unloading area. Please note that this is a minimum measurement. The desired distance between the vehicles – and the reversing lines – should be significantly greater. At least 1,500 mm is required between the vehicles to allow the vehicle’s rear doors to be opened and to facilitate reversing by improving the rear view. The white lights can also be supplemented with red lights. The lights also function as stop lights, since they switch to red when the load carrier has reached a position where it can park in front of the docking system.

Degrees	number of metres
30 degrees	19 m plus free lane and parking
45 degrees	30 m plus free lane and parking
60 degrees	38 m plus free lane and parking
90 degrees	50 m plus free lane and parking

Figure 19: Reversing lines are painted using reflective yellow road paint so that they are easier to see in the winter. Dock seals for 2,600 mm vehicles require a fitting space of 3,600 mm to close tightly around them

3.15 Evacuation

Emergency exits in goods reception areas and warehouses should be avoided since there is a significant risk of them being blocked by goods. If the goods reception nevertheless houses an emergency exit, the points below should be included in the control system that forms part of the systematic fire prevention work:

- Emergency exits should not be blocked.
- Emergency exits should have fluorescent or illuminated exit signs with an emergency power function.
- Emergency exits should have doors that open outwards in the direction of escape with steps to ground level off a landing just outside the door. Gates for vehicle traffic and doors with shutters are not acceptable as emergency exits.
- Emergency exits should be easy to open. They can be equipped with emergency exit pads or panic bars
- Emergency exit doors should be alarmed during the day to reduce the risk of unauthorised access. If emergency exit doors are also used during ordinary operations, they should be equipped with card-readers so that authorised employees can use them without triggering the alarm.
- An emergency exit should be at least 90 cm wide.
- Emergency exits that lead out into the open should be equipped with a device preventing goods from blocking the emergency exit from the outside. This might be a prohibitory sign on the outside of the door stating “Emergency exit: do not block” and a fixed railing two metres in front of the door so that goods and vehicles cannot block the door.

3.16 References

- TYA - the Vocational Training and Working Environment Council (Transport Trades), Sweden; Bättre varumottag! Version 3, 2016.

* * * * *